

## Amos 1 / 5 LEDs

Recessed low glare downlight

Project :	Location :	Type :	Quantity :
Note :			

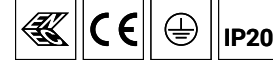

### Luminaire Structure

Recessed, regressed low-glare downlight family  
Perfect controlled lighting environments and no fuss

### Light Symbol



### Ordering guide sample

AM-80001 - N - W30 - DI

Beam
Colour
Dim Type

**Colour Temperature**  
 W27 - Warm 2700K  
 W30 - Warm white 3000K  
 W40 - Neutral white 4000K

**Dimming Type**  
 ND - Non dimmable  
 TE - Trailing edge dimming  
 DI - 1-10V dimmable  
 DA - DALI dimmable

### Product Code

Model No.	Lamp	System Power W	Lumen lm	Colour	Beam Angle	Weight kg
AM-80001 - N - W27	5 LED	9	594	2700K	26°	0.51
AM-80001 - N - W30	5 LED	9	611	3000K	26°	0.51
AM-80001 - N - W40	5 LED	9	664	4000K	26°	0.51
AM-80001 - M - W27	5 LED	9	533	2700K	34°	0.51
AM-80001 - M - W30	5 LED	9	549	3000K	34°	0.51
AM-80001 - M - W40	5 LED	9	596	4000K	34°	0.51
AM-80001 - W - W27	5 LED	9	518	2700K	39°	0.51
AM-80001 - W - W30	5 LED	9	533	3000K	39°	0.51
AM-80001 - W - W40	5 LED	9	579	4000K	39°	0.51

### Dimming Type

ND    TE    DI    DA

### Colour Code

- 08                      - 09

Glossy White  
 RAL 9010

Glossy Black  
 HB451022M

RESET

### Photometric

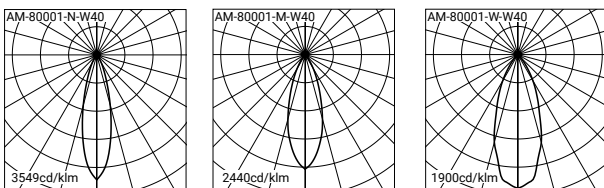

#### HEADQUARTERS EUROPE

Ligman Europe s.r.o.  
VGP Park Ústí nad Labem, P2 | Přestanov 120 | 40317 Přestanov |  
Czech Republic | Tel. +420 477 07 1500 | sales.cz@ligman.com  
www.ligman.com

#### HEADQUARTERS THAILAND

Ligman Lighting Co.,Ltd.  
17/2 | Moo 4 | Monthong | Bangnampreaw | Chachoengsao 24150 |  
Thailand | Tel : +66 (2) 7339140 | info@ligman.com

Ligman Ltd.  
Victory Way | Crossways | Dartford DA2 6QD |  
United Kingdom | Tel +66 2 733 9140 | Fax +66 2 733 9153 |  
sales.uk@ligman.com

Technical amendments reserved.

## Amos 1 / 7 LEDs

Recessed low glare downlight

Project :	Location :	Type :	Quantity :
Note :			

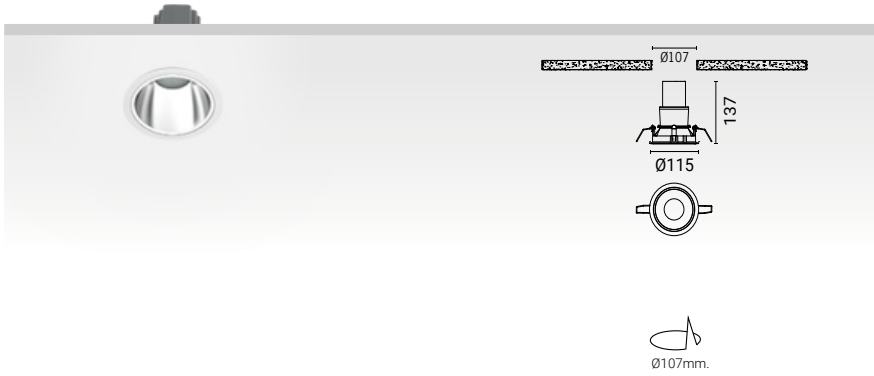
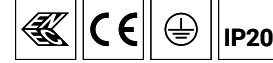

### Luminaire Structure

Recessed, regressed low-glare downlight family  
Perfect controlled lighting environments and no fuss

### Light Symbol



### Ordering guide sample

AM-80011 - N - W30 - DI

Beam Colour Dim Type

Colour Temperature  
W27 - Warm 2700K  
W30 - Warm white 3000K  
W40 - Neutral white 4000K

Dimming Type  
ND - Non dimmable  
TE - Trailing edge dimming  
DI - 1-10V dimmable  
DA - DALI dimmable

### Product Code

Model No.	Lamp	System Power W	Lumen lm	Colour	Beam Angle	Weight kg
AM-80011 - N - W27	7 LED	12	825	2700K	26°	0.51
AM-80011 - N - W30	7 LED	12	849	3000K	26°	0.51
AM-80011 - N - W40	7 LED	12	922	4000K	26°	0.51
AM-80011 - M - W27	7 LED	12	768	2700K	34°	0.51
AM-80011 - M - W30	7 LED	12	790	3000K	34°	0.51
AM-80011 - M - W40	7 LED	12	858	4000K	34°	0.51
AM-80011 - W - W27	7 LED	12	772	2700K	36°	0.51
AM-80011 - W - W30	7 LED	12	794	3000K	36°	0.51
AM-80011 - W - W40	7 LED	12	862	4000K	36°	0.51

### Dimming Type

ND TE DI DA

### Colour Code

- 08      - 09  
Glossy White      Glossy Black  
RAL 9010      HB451022M      RESET

### Photometric

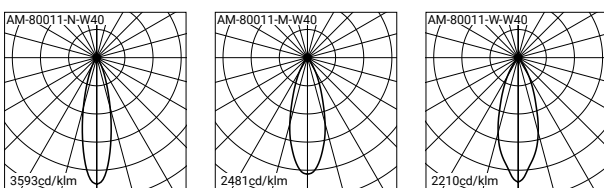

#### HEADQUARTERS EUROPE

Ligman Europe s.r.o.  
VGP Park Ústí nad Labem, P2 | Přestanov 120 | 40317 Přestanov |  
Czech Republic | Tel. +420 477 07 1500 | sales.cz@ligman.com  
www.ligman.com

#### HEADQUARTERS THAILAND

Ligman Lighting Co., Ltd.  
17/2 | Moo 4 | Monthong | Bangnampreaw | Chachoengsao 24150 |  
Thailand | Tel : +66 (2) 7339140 | info@ligman.com

Ligman Ltd.  
Victory Way | Crossways | Dartford DA2 6QD |  
United Kingdom | Tel +66 2 733 9140 | Fax +66 2 733 9153 |  
sales.uk@ligman.com

Technical amendments reserved.

## Amos 2 / 9 LEDs

Recessed low glare downlight

<b>Project :</b>	<b>Location :</b>	<b>Type :</b>	<b>Quantity :</b>
<b>Note :</b>			

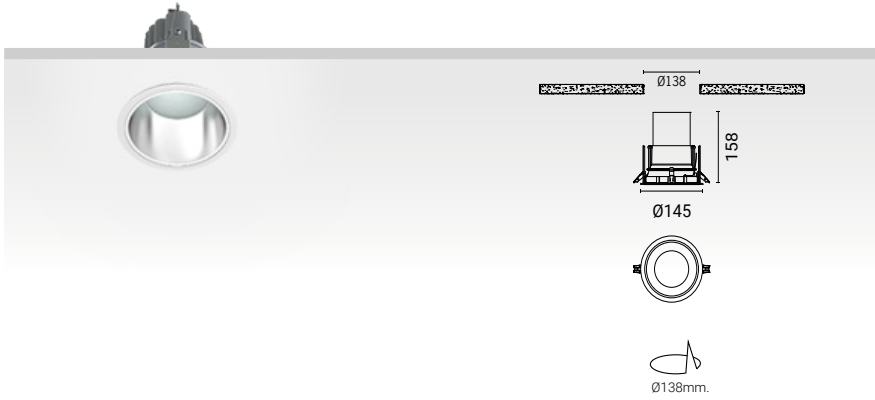
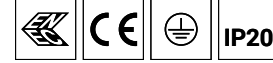

### Luminaire Structure

Recessed, regressed low-glare downlight family  
Perfect controlled lighting environments and no fuss

### Light Symbol



### Ordering guide sample

AM-80021 - N - W30 - DI

Beam
Colour
Dim Type

**Colour Temperature**  
 W27 – Warm 2700K  
 W30 – Warm white 3000K  
 W40 – Neutral white 4000K

**Dimming Type**  
 ND – Non dimmable  
 TE – Trailing edge dimming  
 DI – 1-10V dimmable  
 DA – DALI dimmable

### Product Code

Model No.	Lamp	System Power W	Lumen lm	Colour	Beam Angle	Weight kg
AM-80021 - N - W27	9 LED	15	953	2700K	25°	0.95
AM-80021 - N - W30	9 LED	15	981	3000K	25°	0.95
AM-80021 - N - W40	9 LED	15	1065	4000K	25°	0.95
AM-80021 - M - W27	9 LED	15	925	2700K	33°	0.95
AM-80021 - M - W30	9 LED	15	952	3000K	33°	0.95
AM-80021 - M - W40	9 LED	15	1034	4000K	33°	0.95
AM-80021 - W - W27	9 LED	15	864	2700K	40°	0.95
AM-80021 - W - W30	9 LED	15	889	3000K	40°	0.95
AM-80021 - W - W40	9 LED	15	966	4000K	40°	0.95

### Dimming Type

ND TE DI DA

### Colour Code

- 08      - 09

Glossy White      Glossy Black

RAL 9010      HB451022M      RESET

### Photometric

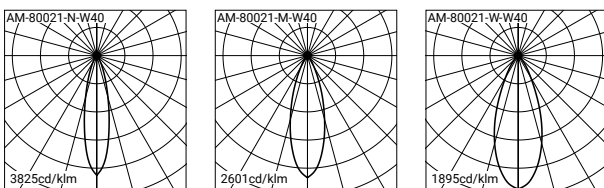

#### HEADQUARTERS EUROPE

Ligman Europe s.r.o.  
VGP Park Ústí nad Labem, P2 | Přestanov 120 | 40317 Přestanov |  
Czech Republic | Tel. +420 477 07 1500 | sales.cz@ligman.com  
www.ligman.com

#### HEADQUARTERS THAILAND

Ligman Lighting Co., Ltd.  
17/2 | Moo 4 | Monthong | Bangnampreaw | Chachoengsao 24150 |  
Thailand | Tel : +66 (2) 7339140 | info@ligman.com

Ligman Ltd.  
Victory Way | Crossways | Dartford DA2 6QD |  
United Kingdom | Tel +66 2 733 9140 | Fax +66 2 733 9153 |  
sales.uk@ligman.com

Technical amendments reserved.

## Amos 2 / 12 LEDs

Recessed low glare downlight

<b>Project :</b>	<b>Location :</b>	<b>Type :</b>	<b>Quantity :</b>
<b>Note :</b>			

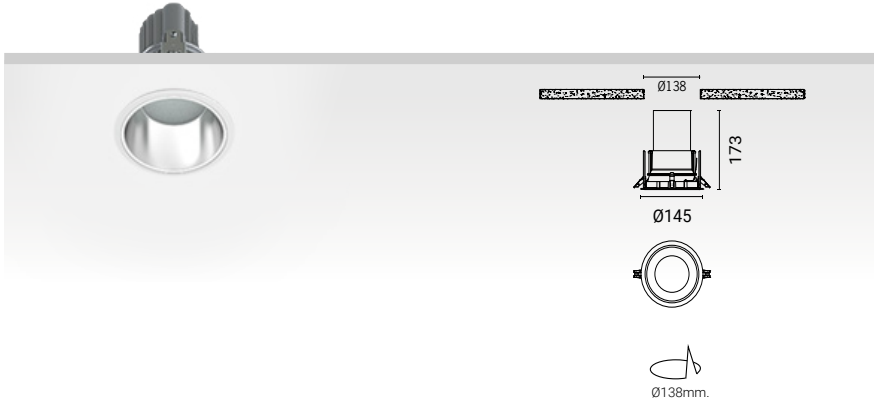

### Luminaire Structure

Recessed, regressed low-glare downlight family  
Perfect controlled lighting environments and no fuss

### Light Symbol



### Ordering guide sample

AM-80031 - N - W30 - DI

Beam   Colour   Dim Type

**Colour Temperature**  
 W27 – Warm 2700K  
 W30 – Warm white 3000K  
 W40 – Neutral white 4000K

**Dimming Type**  
 ND – Non dimmable  
 TE – Trailing edge dimming  
 DI – 1-10V dimmable  
 DA – DALI dimmable

### Product Code

Model No.	Lamp	System Power W	Lumen lm	Colour	Beam Angle	Weight kg
AM-80031 - N - W27	12 LED	20	1277	2700K	25°	0.95
AM-80031 - N - W30	12 LED	20	1314	3000K	25°	0.95
AM-80031 - N - W40	12 LED	20	1427	4000K	25°	0.95
AM-80031 - M - W27	12 LED	20	1240	2700K	33°	0.95
AM-80031 - M - W30	12 LED	20	1276	3000K	33°	0.95
AM-80031 - M - W40	12 LED	20	1385	4000K	33°	0.95
AM-80031 - W - W27	12 LED	20	1158	2700K	40°	0.95
AM-80031 - W - W30	12 LED	20	1192	3000K	40°	0.95
AM-80031 - W - W40	12 LED	20	1294	4000K	40°	0.95

### Dimming Type

ND   TE   DI   DA

### Colour Code

- 08      - 09

Glossy White      Glossy Black

RAL 9010      HB451022M      RESET

### Photometric

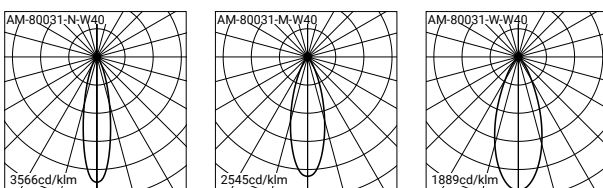

#### HEADQUARTERS EUROPE

Ligman Europe s.r.o.  
VGP Park Ústí nad Labem, P2 | Přestanov 120 | 40317 Přestanov |  
Czech Republic | Tel. +420 477 07 1500 | sales.cz@ligman.com  
www.ligman.com

#### HEADQUARTERS THAILAND

Ligman Lighting Co., Ltd.  
17/2 | Moo 4 | Monthong | Bangnampreaw | Chachoengsao 24150 |  
Thailand | Tel: +66 (2) 7339140 | info@ligman.com

Ligman Ltd.  
Victory Way | Crossways | Dartford DA2 6QD |  
United Kingdom | Tel +66 2 733 9140 | Fax +66 2 733 9153 |  
sales.uk@ligman.com

Technical amendments reserved.

## Amos 3 / 18 LEDs

Recessed low glare downlight

Project :	Location :	Type :	Quantity :
Note :			

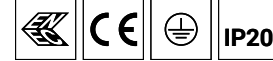
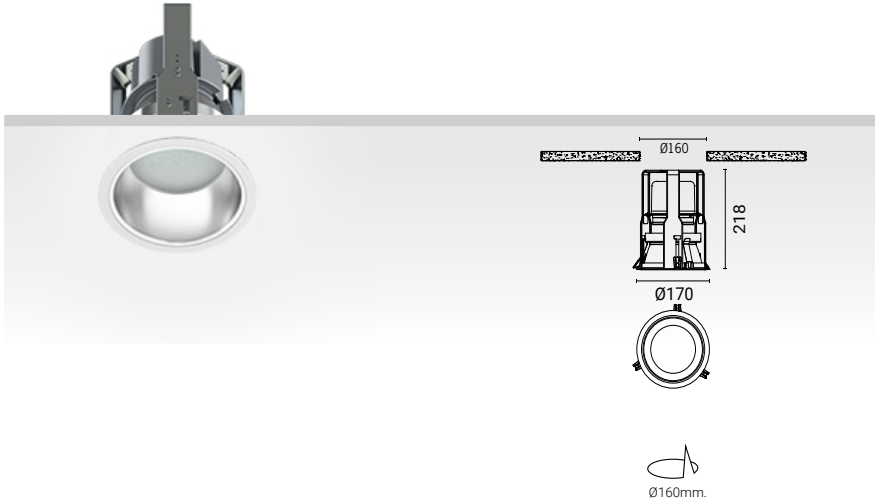

### Luminaire Structure

Recessed, regressed low-glare downlight family  
Perfect controlled lighting environments and no fuss

### Light Symbol



### Ordering guide sample

AM-80041 - N - W30 - DI

Beam   Colour   Dim Type

**Colour Temperature**  
 W27 – Warm 2700K  
 W30 – Warm white 3000K  
 W40 – Neutral white 4000K

**Dimming Type**  
 ND – Non dimmable  
 DI – 1-10V dimmable  
 DA – DALI dimmable

### Product Code

Model No.	Lamp	System Power W	Lumen lm	Colour	Beam Angle	Weight kg
AM-80041 - N - W27	18 LED	29	2083	2700K	25°	1.59
AM-80041 - N - W30	18 LED	29	2143	3000K	25°	1.59
AM-80041 - N - W40	18 LED	29	2327	4000K	25°	1.59
AM-80041 - M - W27	18 LED	29	2024	2700K	33°	1.59
AM-80041 - M - W30	18 LED	29	2082	3000K	33°	1.59
AM-80041 - M - W40	18 LED	29	2261	4000K	33°	1.59
AM-80041 - W - W27	18 LED	29	1767	2700K	42°	1.59
AM-80041 - W - W30	18 LED	29	1818	3000K	42°	1.59
AM-80041 - W - W40	18 LED	29	1974	4000K	42°	1.59

### Dimming Type

ND    DI    DA

### Colour Code

- 08                      - 09

Glossy White            Glossy Black

RAL 9010                HB451022M            RESET

### Photometric

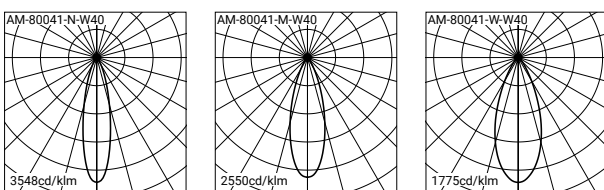

#### HEADQUARTERS EUROPE

Ligman Europe s.r.o.  
VGP Park Ústí nad Labem, P2 | Přestanov 120 | 40317 Přestanov |  
Czech Republic | Tel. +420 477 07 1500 | sales.cz@ligman.com  
www.ligman.com

#### HEADQUARTERS THAILAND

Ligman Lighting Co., Ltd.  
17/2 | Moo 4 | Monthong | Bangnampreaw | Chachoengsao 24150 |  
Thailand | Tel: +66 (2) 7339140 | info@ligman.com

Ligman Ltd.  
Victory Way | Crossways | Dartford DA2 6QD |  
United Kingdom | Tel +66 2 733 9140 | Fax +66 2 733 9153 |  
sales.uk@ligman.com

Technical amendments reserved.

## Amos 4 / 24 LEDs

Recessed low glare downlight

Project :	Location :	Type :	Quantity :
Note :			

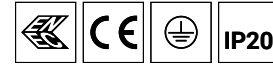
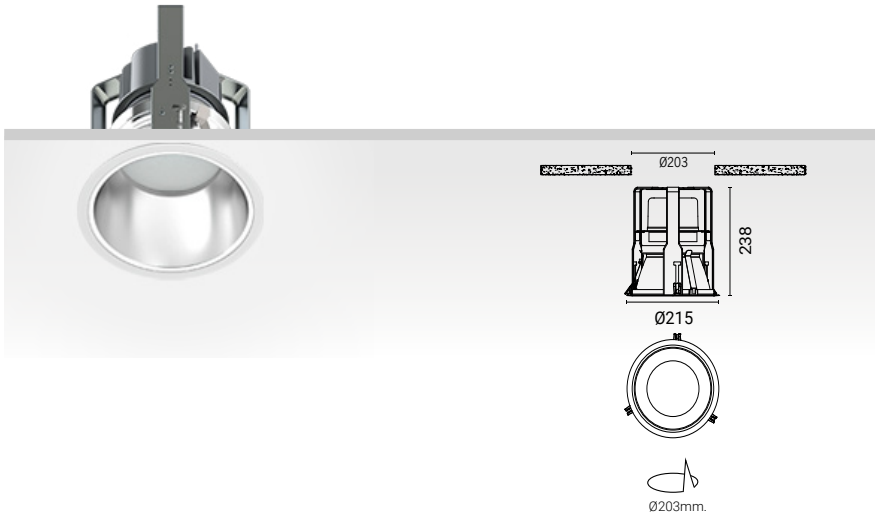

### Luminaire Structure

Recessed, regressed low-glare downlight family  
Perfect controlled lighting environments and no fuss

### Light Symbol



N - Narrow beam



M - Medium beam



W - Wide beam

### Ordering guide sample

AM-80051 - N - W30 - DI

Beam
Colour
Dim Type

**Colour Temperature**  
 W27 - Warm 2700K  
 W30 - Warm white 3000K  
 W40 - Neutral white 4000K

**Dimming Type**  
 ND - Non dimmable  
 DI - 1-10V dimmable  
 DA - DALI dimmable

### Product Code

Model No.	Lamp	System Power W	Lumen lm	Colour	Beam Angle	Weight kg
AM-80051 - N - W27	24 LED	39	2644	2700K	25°	1.59
AM-80051 - N - W30	24 LED	39	2721	3000K	25°	1.59
AM-80051 - N - W40	24 LED	39	2954	4000K	25°	1.59
AM-80051 - M - W27	24 LED	39	2720	2700K	33°	1.59
AM-80051 - M - W30	24 LED	39	2799	3000K	33°	1.59
AM-80051 - M - W40	24 LED	39	3039	4000K	33°	1.59
AM-80051 - W - W27	24 LED	39	2457	2700K	44°	1.59
AM-80051 - W - W30	24 LED	39	2528	3000K	44°	1.59
AM-80051 - W - W40	24 LED	39	2745	4000K	44°	1.59

### Dimming Type

ND    DI    DA

### Colour Code

- 08                      - 09

Glossy White  
 RAL 9010

Glossy Black  
 HB451022M

RESET

### Photometric

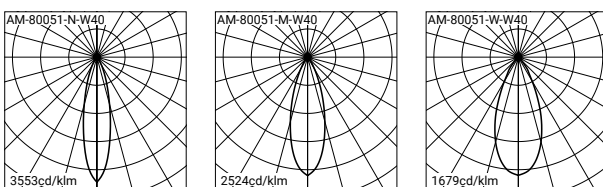

#### HEADQUARTERS EUROPE

Ligman Europe s.r.o.  
VGP Park Usti nad Labem, P2 | Přestanov 120 | 40317 Přestanov |  
Czech Republic | Tel. +420 477 07 1500 | sales.cz@ligman.com  
www.ligman.com

#### HEADQUARTERS THAILAND

Ligman Lighting Co.,Ltd.  
17/2 | Moo 4 | Monthong | Bangnampreaw | Chachoengsao 24150 |  
Thailand | Tel : +66 (2) 7339140 | info@ligman.com

Ligman Ltd.  
Victory Way | Crossways | Dartford DA2 6QD |  
United Kingdom | Tel +66 2 733 9140 | Fax +66 2 733 9153 |  
sales.uk@ligman.com

Technical amendments reserved.